



中国华信
CEFC CHINA

ZDAS

CEFC Group Member

company profile



History of Iron Making in the Highlands

1252

first prospectors came to the region after establishment of the Žďar Cistercian monastery, looking for silver and later on for iron ore

1366

the village Polnička by Žďar; 1406 – Žďar nad Sazavou – first written records of direct production of iron in the iron-mills with reduction furnaces

1614

commencement of the operation of the first blast furnace with the indirect method of iron making in the premises of the Žďar monastery

1838

the operation of the rail rolling mill commenced in the ironworks in Polnička by Žďar. The complex of iron works in the area of Ransko and Polnička was one of the largest ones in the Czech lands that time and it supplied metallurgical and engineering products throughout Europe

1886

due to switch-over to iron making with black coal utilization and because of the long lasting crisis, the iron making in the Žďar area was ended off and dissolved

1951

production commencement in the new metallurgical and engineering complex of the Žďar engineering and foundry works, the present joint stock company ŽĎAS

1992

transformation of the state-owned firm into the joint stock company ŽĎAS

2002

entry of the strategic partner and the majority owner, the Slovak company Železiarne Podbrezova, a.s.

2016

the Chinese company CEFC Group (Europe) Company became the owner of the joint-stock company ŽĎAS

Who are we?

ŽĎAS, a.s. is a significant supplier of piece deliveries as well as automated units of forming machines, rolled product processing equipment and metallurgical products to nearly fifty countries of five continents.

ŽĎAS, a.s.
591 01 Žďár nad Sázavou
Czech Republic
www.zdas.cz

ID No.: 46347160

Tax ID No.: CZ46347160

Production commenced: 27. 08. 1951

Establishment of the joint stock company:
30. 04. 1992, according to § 172 of Business
Code § 11clause 3 of Law No. 92 /1991



Strategic Partner



中国华信
CEFC CHINA

The joint stock company ŽĎAS was established after the transformation of the state-owned firm ŽĎAS in accordance with the approved privatisation project pursuant to §172 of Law No. 513/1991 of Digest of Business Code, based on uniphase establishment by the founder – State Property Fund of the Czech Republic – under the founder's deed dated 28. 04. 1992.

On 10 August 2016 the CEFC Group (Europe) Company a. s., which is resident in Prague, became the new owner of ZDAS a.s. Simultaneously with this transaction the CEFC became the owner of the subsidiary TS Plzeň a. s. and gained the majority of the shares in the German company ZDAS SGS GmbH.

The new owner's strategy is not only to maintain the volume of production and support the best quality of the product offered, stability and employment, but also to obtain other new business opportunities and thereby assist in further development and realization of new business transactions both on the etabled and new markets. CEFC China Energy Company Limited is the biggest private company in Shanghai and the sixth biggest private company in China. This company is also ranked among 500 world's biggest companies. In 2016 the CEFC was rated 229th on the prestigious ranking list - Fortune Global 500. CEFC is operating in particular in the field of finance, energy and industry. The company CEFC has its representations for example in the USA, Great Britain, Canada, Mexico, Russia, United Arab Emirates, Indonesia, Singapur or Sourth Korea. The company employs more than 21 thousands people all over the world.

ŽĎAS, a.s. is a holder of the international certification within the Integrated Management System comprising:

- Research and development of technologies and production of castings, forgings, ingots and patterns
- Research, development, production, assembly, putting into operation and service of rolling mill equipment, forming machines and tooling and parts of machines according to customer-provided specification
- Generation and distribution of energies and mediums
- Welding with regard to higher requirements for quality according to EN ISO 3834-2

Certification of products by the world leading certification societies takes up the Integrated Management System certification. ŽĎAS, a.s. is the holder of many product certificates enabling production of specified parts intended for the most demanding engineering branches.



Basic References

- highly qualified and stabilized production and technical personnel
- modern production and development base
- **international certification in accordance with the standards EN ISO 9001:2008, EN ISO 14001:2004, OHSAS 18001:2007**
- high-quality international references in all production branches
- application of principles of safety and health protection at work and their implementation into the existing or the new operations
- for the up-to-date list of product certificates, see www.zdas.cz



Production Program

Forming machines

Open die forging equipment
Metal scrap processing equipment
Hydraulic presses
Mechanical presses
Reconstruction and modernisation

Rolled product processing equipment

Material straightening equipment
Inspection lines and straightening lines
for bar finishing
Sheet dividing lines
Piece deliveries for rolling mills
Reconstruction and modernisation

Manufacture of equipment acc. to customer-provided documentation

Metallurgy

Steel production from 500 to 12,000 kg
Forgings from 20 to 9,000 kg
Castings from 200 to 40,000 kg
Patterns

Tooling

For automotive industry
For transfer forming
For consumer industry
For special production
Engineering production

Services

External assembly • Measurement
Material tests • Service
Hotel Svratka • Lodging-house



F Forming Machines

Open Die Forging Equipment

Integrated forging units consist of a forging press with hydraulic drive and one or two forging manipulators. The unit can be equipped with an ingot bogie, a turntable, a tooling manipulator and further accessories.

Hydraulic forging presses CKW are pull-down, with the advantage of the lowness above the hall floor. Nominal forming force: from 6,300 to 40,000 kN.

Push-down forging presses CKVX represent a new design of the equipment. Their advantage is the rigid guide frame. Nominal forming force: from 6,300 to 32,000 kN.

Push-down forging presses CKV represent the equipment intended for halls with shallow base. These presses are able to forge also with a big eccentricity of forging force. Nominal forming force: from 6,300 to 32,000 kN.

Rail-bound forging manipulators QKK are intended for handling the heated forging. Manipulator carrying capacity: from 1.5 to 120 tons.

Metal Scrap Processing Equipment

Container shears CNS 400 K and CNS 320 K are suitable for cutting bulky and bar scrap in places where the scrap occurs. Maximum cutting force: 4,000 kN.

Hydraulic scrap shears CNS 730 is designed as semi-mobile ones, so they can be easily transported to places where the scrap occurs. Nominal cutting force: 7,300 kN.

Stationary hydraulic scrap shears CNS are intended for cutting heavy bulky scrap or amortisation scrap. They are equipped with the technology of pressing before cutting, swinging pressing walls and the possibility of both cutting and baling. Nominal cutting force: from 8,000 to 16,000 kN.

Baling presses CPS are designed for effective processing of cuttings from pressing shops. Nominal pressing force: from 1,600 to 10,000 kN.

Baling presses CPB are intended for processing of light scrap. Nominal forming force: from 1,000 to 4,000 kN.

Presses HDP 2000 are intended for compacting of barrels with contaminated waste. Nominal forming force: 2,000 kN.

Hydraulic Presses

Hydraulic presses CYA, CYAB are intended for production of parts for the automotive industry, they are adapted to hot operation. Nominal forming force: from 4,000 to 18,000 kN.

Hydraulic straightening presses CDN, CDT, RL are intended for straightening of shafts, sheet metal, welded parts, castings and forgings. Nominal forming force: from 4,000 to 10,000 kN.

Hydraulic presses CTH, CTC represent a universal series of equipment for common operations of both volume and sheet metal forming. Nominal forming force: from 2,500 to 10,000 kN.

Isostatic presses CJZ, CYX designed for pressing of metal and non-metallic material by means of all-round pressure, eventually for preservation of food. Nominal working pressure above atmospheric: from 100 to 600 MPa.

Presses for assembly and disassembly of railway wheel sets CDR and CDRA are intended for assembling and dismantling of railway wheel sets. Nominal forming force: 5,000 kN.

Mechanical Presses

Screw presses LVE are designed for die forging and for pressing operations. Nominal forming force: from 1,600 to 25,000 kN.

One-point crank presses LKJA are intended for pressing and forging operations. Nominal forming force: from 2,500 to 10,000 kN.

One-point crank presses LKJP are widely used for both cold and hot forming. Nominal forming force: 4,000 kN.

Two-point crank presses LKDA are intended for most pressing operations. Nominal forming force: from 3,150 to 8,000 kN.

Two-point crank presses LKDK with articulated mechanics are intended for car body-forming and pressing operations. Nominal forming force: from 3,150 to 8,000 kN.

Two-point crank presses LKDR with a variable size of stroke are designed for pressing by means of progressive dies. Nominal forming force: from 2,000 to 5,000 kN.

Integrated Forging Units

ŽDAS, a.s. in co-operation with the filial company TS Plzeň, a.s. offers and delivers the whole range of forging presses in the design of two-column, four-column, pull-down and push-down, from 6,300 to 150,000 kN. We offer forging manipulators with all dimensions of presses, with the maximum carrying capacity up to 120 tons. Delivery of all further auxiliary equipment and integration of the whole unit is the matter of course.

ZDAS



Classification of Hydraulic Forging Presses

PUSH-DOWN PRESSES

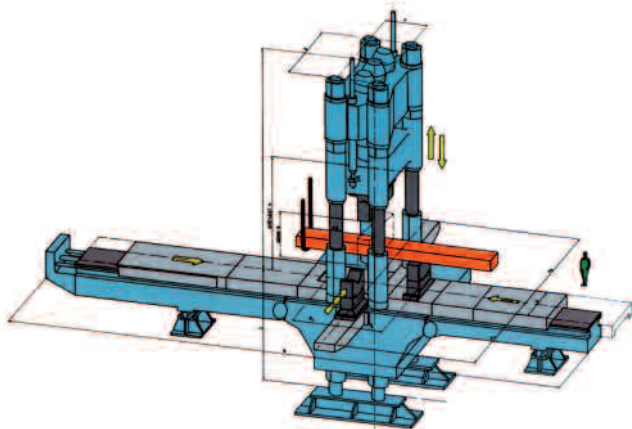

PULL-DOWN PRESSES

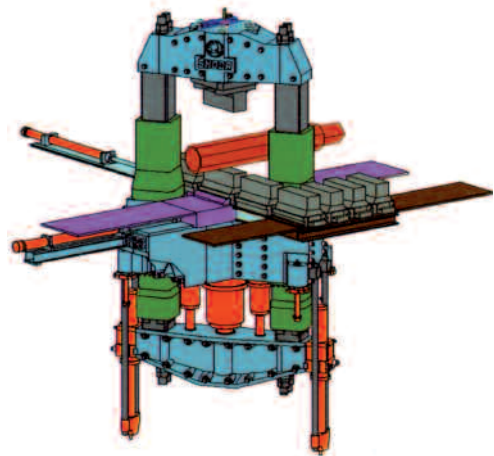

Forging Units of New Generation

The forging press CKV 1250/1600 is of push-down four-column design with a maximum nominal force of 12.5 MN and with an increased up-setting force of 16 MN. The press is equipped with the moving table, bottom-die shifting device and upper-die clamping device. The great distance between the upper and bottom guides guarantees low reactions in the guides when eccentric loading of the press. The forging unit is integrated with the QKK 8 rail guided forging manipulator designed according to development and research of new conception. Lower weight and smaller dimensions of the equipment as well as higher speed and easier maintenance are the advantages of the equipment. The unit is operating in the own ZDAS's forging shop, thus enabling verification of experience and further development.





Integrated Forging Units to the Whole World

Integrated forging units represent one of the basic groups of the supplied forming machines within the production programme of the joint stock company ŽDAS. Integration of forging units provides economical production in precise tolerances. Shortening of operational and supplementary times optimises the whole manufacturing process, all movements of the unit are read by linear contactless sensors and the system of program forging enables production in small series.

Based on long-term experience and successful references from deliveries for customers in Germany, Japan, U.K. and other countries, ŽDAS Company handed over to India's Bharat Forge Limited based

in Puna its integrated forging unit with a CKW 4000 press in June 2008.

According to the customer's requirement, the equipment has been installed with a rail manipulator QKK 35, an ingot bogie QHK 50 and a rotary forging table QKW 40. The complete unit has been supplied with electric equipment and integrated with the control system. ŽDAS Company managed the assembly at the customer for less than a half-year. Operation tests took place after inspection and debugging and met all requirements concerning the contract parameters. The equipment has been designed for production of intricate forgings in manual as well as semi-automatic mode.

Tongs of Forging Manipulator that Can Lift 100 Tons

Forging manipulators ŽĐAS are intended for handling the forged piece within the workspace of the forging press. The basic series consists of rail manipulators QKK that enable to perform intricate open-die forging production operations as well as forging in small series.

The manipulator is fully integrated with the press and further equipment so the operating personnel is able to control all machines from the operator's cabin and handle intricate forgings in the set parameters.

Each manipulator is equipped with number of sensors monitoring its main movements, i.e. travel, turning of tongs and vertical movement of tongs. The data

from these sensors can be used by the control system and can be also utilized in the automatic mode of operation.

If the unit uses two interconnected opposite manipulators, long forgings can be handled also when the manipulator movements have to be operated so that the necessary longitudinal tensile stress is in the forged part in every moment.

ŽĐAS Company has designed and supplied the manipulator QKK 100 intended for production of intricate parts of large ship motors for a Chinese customer. Tongs of this manipulator are able to handle an ingot of 100 tons of which a product is forged afterwards.

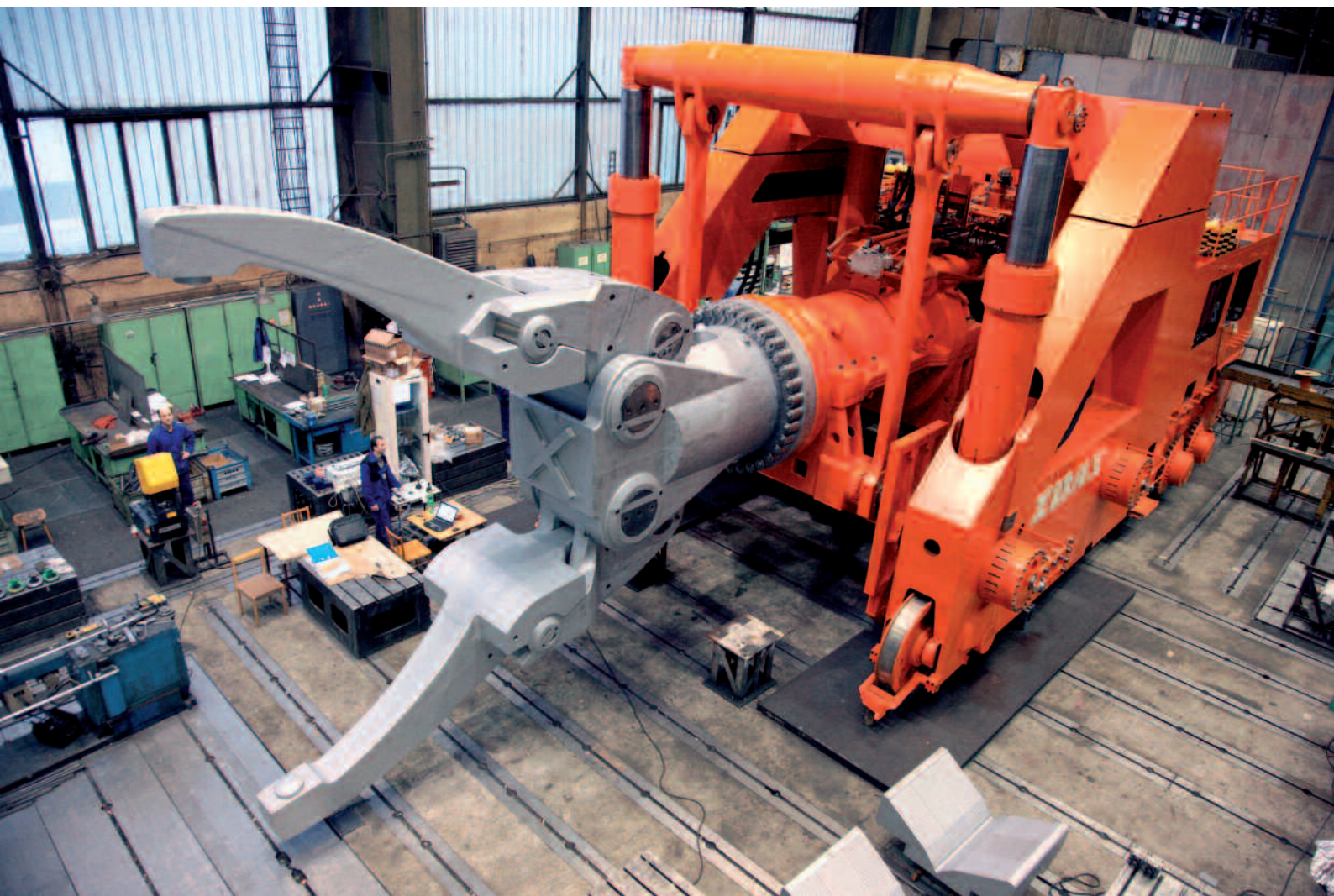



Offer of ŽDAS's Equipment for Baling and Shearing

Pieces produced

Scrap baling	Amortisation and processing metal scrap	Baling presses CPB 100, 200	105
	Metal scrap from pressing shops	Baling presses CPS 160, 320	21
	Amortisation and processing metal scrap, especially for metal scrap treatment works	Baling presses CPS 630, 1000, 1250 Baling presses CPB 400, 630, 1000	164 256
	Light bulky metal scrap	Mobile baling press CPM 140	3
Scrap shearing	Light bulky metal scrap	Shears CNS 630-S	2
	Light bulky and bar scrap	Container shears CNS 400 K Container shears CNS 320 K Shears CNS 730 SM	180 22 5
	Heavy bulky scrap	Shears CNS 800-100-CV2, 1100-100-CV2, 1600-100-CV2 Shears CNS 800, 1250, 2000	6 95
Scrap shearing and baling	Shearing – mainly bar material Baling – light bulky scrap	Mobile baling and shearing press CPNM 400	1
	Baling and shearing of the bulky dimensional scrap	Baling and shearing press CPN 400, CPN 630	39

Comparison of specific weights of the steel scrap before and after processing

	BALING		SHEARING
	CPS	CPB	
Scrap before processing (kg/m ³)	120 ÷ 350		
Scrap after processing (kg/m ³)	2 000 ÷ 3 500	2 000 ÷ 3 000	530 ÷ 780
Specific weight increase (after processing)	Up to 29 times	Up to 25 times	Up to 6.5 times



Displaceable Shears

Displaceable container shear is produced in two dimensions, CNS 400 K and CNS 320 K differing in the maximum cutting force and in the total weight of the shear. Base of the shear consists of a reinforced bottom of the pull-on container – in this case serving as a working surface where tool slides and the processed scrap moves horizontally. One of important advantages is utilisation of gravity for moving the scrap into the holder area, and horizontal movement that enables constant dispatch of the processed metal scrap. Remote control of the shear and continuous operating of shear are the main reasons of high hourly output – up to 12 tons of scrap per hour. Design of the shear CNS 730 represents further development of easily displaceable shear. Its cutting force has been increased and dimensions of the working space adapted. While the smaller shear is being displaced as a container, the semi-mobile

shear is equipped with four tipping hydraulic supports enabling the semitrailer to run up and out. Apart from Diesel engine, all types of the shear can be also designed with an electric motor.



Transportation of CNS 400 K container shear



Container shears CNS 400 K



Semi-mobile shears CNS 730 SM

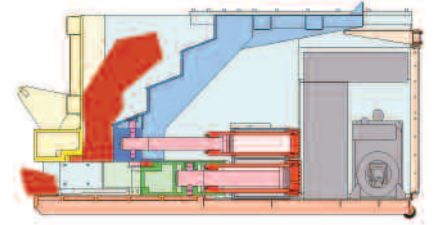
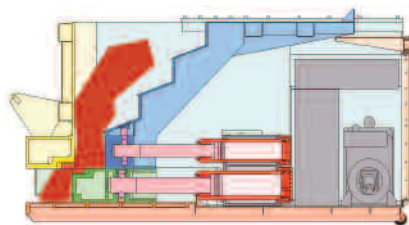
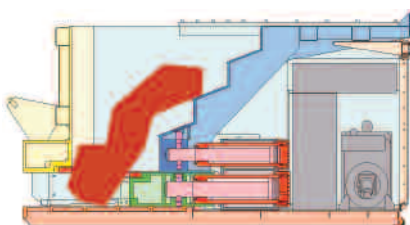

Technological process of shearing in container shears



Hydraulic Shears to Any Weather

The ŽDAS Company supplied hundreds of scrap processing equipment to the wide Russian market. An innovated type of CNS 1100-CV2 stationary scrap shear has been supplied to the metallurgical combine NLMK Lipeck. Three pieces of the shears are intended for cutting larger volumes of heavy, bulky or amortisation metal scrap material. Design of the shear enables to cut bulky scrap with minimum preliminary treatment. The shear is able to cut metal scrap up to the diameter of 200 mm, with the output up to 44 tons per hour. At present, shears with different lengths of charging area are supplied.



CNS 1100-CV2 shear – shorter design



CNS 1100-CV2 shear with long hopper



Delivery of the Presses CPS 320 for Automotive Factories VW Wolfsburg and Hannover

Lately, ŽDAS Company has supplied three complete, fully automated units of CPS 320 baling presses to the demanding market of the leading European automotive factory VOLKSWAGEN. Two workplaces in VW Wolfsburg and one in VW Hannover are concerned. Sheet metal scrap from pressing shops is transported into a dumping chute by the baling press by a system of conveyers. From the dumping chute,

the scrap slides into the hopper of the dosing and weighing device. The dose of the scrap is weighed precisely so that the specified tolerance of the length of bales is kept. Then, during three independent operations, the scrap is successively compacted into a right parallelepiped shape (bale) and slipped out into the bales outlet. The last operation (recompressing) is fitted with a linear sensor of length.



Technical Parameters of CPS 320 (VW Hannover)

Processed material	steel sheet scrap max. thickness 6 mm
Strength of material	R_m max. 450 MPa
Cycle (bale of 200 kg)	31 sec./bale
Dimensions of charging chamber (length x width x height)	2,000 x 1,400 x 1,250 mm
Dimensions of bale (width x height x length)	400 x 400 x 400-800 mm
Compacting	35-46 %
Weight of bale	200-400 kg
Output	116 bales/hour
Power input in total	225 kVA
Control system	SIMATIC S7-300 (Siemens)
Lubrication of press	oil + grease



Successful Presses for Safety Stiffeners of Car Bodies

ŽDAS, a.s. ranks among the leading producers of hydraulic machines and equipment. Thanks to long-time experience, the company produces a wide range of presses with hydraulic drive. The CYAB hydraulic press is designed to press safety stiffeners of car bodies and /or it can be used for other pressing operations according to technological possibilities of the equipment. The pressing takes place when hot. High safety factors of particular pieces are reached by means of quenching right in the tool. The press is of vertical welded design. Located in the press frame upper part are four differential working cylinders and the slide is guided along the octagonal square guide. The hydraulic drive is located on the press platform. The press is integrated in automatic production lines with the maximum possible level of mechanization and automation of the production processes.





Presses for Railway Wheel Set Treatment

Hydraulic press CDRA is intended for assembling of railway wheel sets, for cold pressing, without guide bushes, with axle rotation. The equipment enables pressing on including the components between wheels. Apart from pressing on, the equipment also enables compressing and checking of the pressed on connections. The press is horizontal, of a column structure. The press cylinder located in the fixed

crossbeam acts by means of the selected force over the pressed parts against the supporting crossbeam. The crossbeam moves in the threaded anchors to the adjusted metered position. Hydraulic centring of the wheel is located on the supporting crossbeam, while hydraulic centring of the axle is located on the back crossbeam. The control system provides control of the press and diagnostics of the operation and failure states.

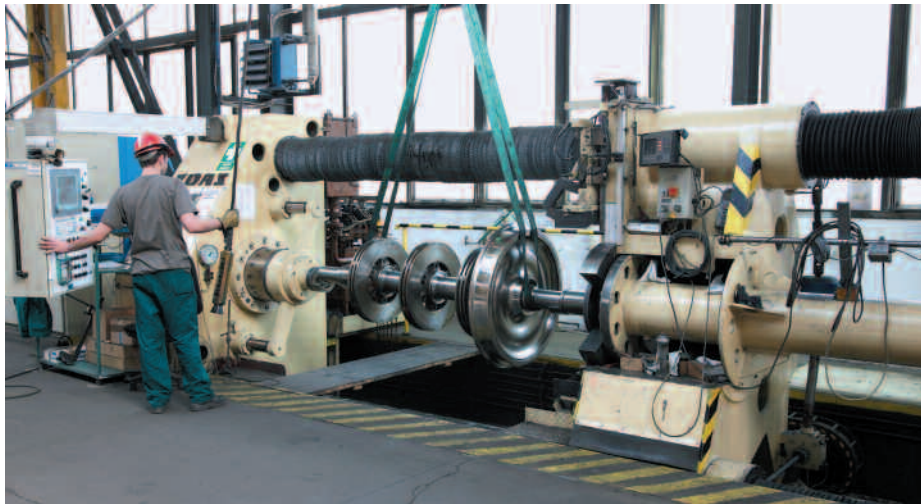

Straightening Press for Bar Material

Hydraulic straightening press CDT 1000 is intended for cold straightening of circular and four-square sections. The press consists of a working cylinder fastened onto the press frame. Input and output conveyers ensure movement of straightened pieces. The straightened section bears on adjustable supports. Chain manipulators on both sides of the press are intended for handling – turning – of the straightened sections. The couple of chain manipulators on the output side serves for handling short sections. Drive of the press and the chain manipulators is hydraulic and is located behind the working cylinder. The control system ensures control of the press and diagnostics of the operation and failure states.





Selected References of Forming Machines after the Year 2000

- 
- Integrated forging unit CKW 3300/4000 + QKK 35 + QKK 15 (England – SOMERS FORGE)
Integrated forging unit CKV 2650 (reconstr.) + 2 x QKK 20 (India – MSF Ishapore)
Integrated forging unit CKW 630 + QKK 3 (Germany – Von Schaewen)
Integrated forging unit CKV 630 + QKK 3 (Czech Republic – ŽĎAS, Žďar nad Sazavou)
Forging unit CKZW 5600/6500 + QMS 1,3 (Czech Republic – BONATRANS, Bohumin)
Integrated forging unit CKVX 1000 + QKK 5 (Romania – S.C. Forja Neptun Campina)
Integrated forging unit CKW 4000 + QKK 35 + QHK 50 + QWK 40 (India – Bharat Forge Limited, Pune)
Forging press CKW 4000 (Germany – BGH Siegen)
Forging press CKW 1800 (Japan – NAKAMURA Iron Works)
Forging manipulator 2 x QKK 20 (India – MSF Ishapore)
Forging manipulator QKK 35 (Czech Republic – ŠKODA KOVARNY Plzeň)
Forging manipulator QKK 35 + QHK 35 (China – Luoyang Mining)
Forging manipulator QKK 35 (Russia – EZTM)
Forging manipulators QKK 100 (China – CSOC / Wuhan Heavy Casting & Forging)
Baling press CPB 100 (Czech Republic – SG Equipment Prague)
Baling press CPS 320 (Germany – Volkswagen Wolfsburg)
Baling press CPS 320 (Germany – Volkswagen Hannover)
Scrap shears CNS 400 K (Germany – MHS, Stuttgart)
Scrap shears CNS 400 K (Germany – Prometall, Fellbach)
Scrap shears CNS 400 K (Germany – Peter Struck, Johanngeorgenstadt)
Scrap shears CNS 400 K (Belgium – Metallo-Chimique, Beerse)
Scrap shears CNS 400 K (Russia – Severstal Vtormet Nižnij Novgorod)
Scrap shears CNS 1100 – 3 pieces (Russia – Lipeck)
Scrap shears CNS 1100 (Czech Republic – Eko-Logistic, Tynec nad Labem)
Scrap shears CNS 1100 – 2 pieces (Romania – Ductil Steel)
Hydraulic press for automotive plastic parts CYAA 1800 (Czech Republic – Rieter Elitex, Choceň)
Hydraulic presses for automotive high-strong parts CYAB 400, CYAB 800 (Czech Republic – Benteler Chrastava)
Straightening press CDT 1000 (Germany – SSK von Schaewen)
Hydraulic presses for railway wheel set CDRA 500 (Slovakia – ŽOS Trnava, Russia – Unimatic Jekatěrinburg)
Isostatic press CJZ 4/0510 (Czech Republic – UJP Prague)
Universal hydraulic press CTHA 700 (India – OF Kanpur)
Bag press CTV 16000 (Poland – PZL Swidnik)
Two-point crank press LKDR 315 (Sweden – Pallco AB)
Two-point eccentric press LKDE 400 (Czech Republic – TES Vsetin)
Unit for forging of automotive valves LVE 250 (China, Czech Republic)
Unit for forging of die forgings with the press LVE 1600 (Slovakia – PRAKO-PRIRUBY Prakovce)
- General repairs and modernisation of equipment by other manufacturers:
- Reconstruction of the forging press CKV 3000 (Russia – EZTM)
 - Reconstruction of the hydraulic press CKQ 630, incl. accumulator station (Egypt – Helwan Factory 99)
 - Reconstruction of 5 pieces of crank presses PKZV 1250 – 3rd pressing line (Czech Republic – ŠKODA Auto Ml. Boleslav)
 - LVH 1600 press – reconstruction (Czech Republic – Strojmetal Kamenice)



Rolled Product Processing Equipment

Material Straightening Equipment

Straightening equipment can be incorporated into sections of preparation plants of rolling trains, inspection lines or individual straightening lines. In straightening lines, the straightened material is transferred to straightening machines by means of roller conveyors located at the input and output.

Round bars and tubes straightening equipment is supplied as individual machines or complete lines for straightening of steel and non-ferrous metal bars and tubes of diameters from 5 to 300 mm.

Sections and rails straightening equipment is supplied in horizontal or vertical design and with a fixed or movable pitch of working rolls. Straightening machines include the equipment for exchange of straightening passes.

Sheet metal straightening equipment is intended for hot and cold rolled sheet metal up to the width of 4,000 mm and the max. thickness of 50 mm.

Inspection and Straightening Lines

Inspection and straightening lines for hot rolled bars processing are intended for output plants of metallurgical combines and rolling mills. They enable charging and intake of bar bundles, their separation, technological treatment such as blasting, grinding, straightening, peeling, finish machining, flaw detection of surface and inner defects, sorting out of defective bars, separating to commercial lengths, de-pointing and marking. At the output from the line, the bars are arranged to bales, bound up and transported to the dispatch store.

Sheet Dividing Lines

Sheet slitting lines are intended for slitting a strip to narrower coils or strips that are used for further processing. The strip coil treated: strip thickness from 0.15 to 12.5 mm, maximum width 1 800 mm, maximum coil weight 30 tons.

Sheet cut-to-length lines enable cut-to-length dividing of a strip to tables of required lengths. The strip coil treated: coil thickness from 0.15 to 12.5 mm, maximum width 1 800 mm, maximum coil weight 30 tons. The supplied lines can operate in the start-stop system or in the continuous uninterrupted material flow. With 1 000 m wide packing sheet of the thickness from 0.15 to 0.6 mm, cutting precision of ± 0.15 mm at 7 cuts per sec. and strip speed of 300 m/min. is achievable.

Combined dividing lines represent technological connection of cut-to-length and slitting lines, with accordant input and output parameters.

Compact shearing and straightening machine represents a special compact design of combined dividing lines. The compact shearing and straightening machine enables both slitting and cut-to-length dividing of coiled sheet strips. The coiled strip of the weight up to 10 tons is simultaneously straightened and slit in up to 6 strands that are finally cut to the required length. The strip thickness is from 0.4 to 2 mm, width from 800 to 1,550 mm. Cutting precision of ± 0.3 mm is achievable at the speed of 30 m/min.

Piece Deliveries of Rolled Product Processing Equipment

Shears

- **Shears for strip dividing to tables:** flying shears (strip moving) – drum shears (cutting accuracy ± 0.15 mm), crank shears (cutting accuracy ± 0.3 mm), pendulum (cutting accuracy $+ 0.6$ mm/m of the length), stationary (strip not moving) – hydraulic, mechanical
- **Circular shears for slitting and trimming of strip** (cutting accuracy from $+ 0.00$ to 0.05 mm)
- **Shears for sections and billets**

Uncoilers and recoilers intended for processing of a coil of the weight from 3 to 30 tons have been designed with an overhung pin, a supported pin or a double pin. They can be designed with upper or lower uncoiling and recoiling.

Cooling beds and transportation equipment

Cooling beds are intended for cooling of rolled bars, sections, billets and they are incorporated in the output from the rolling mill or the continuous casting. They are framed as reversing and step-by-step ones.

Transportation equipment is intended for longitudinal and transversal transportation of rolled sections and sheets.

Gearboxes, assemblies of drives, claw clutches and claw spindles

The main types of gearboxes are spur gearboxes, bevel and spur-bevel gearboxes and worm gear units. They are combinable with distribution gears with two or several output shafts and the change of the gear ratio – changeable.

They serve for any drive of a machine such as for example rolling mills, straightening machines, shears, etc. They are incorporated in assemblies of drives including motor claw clutches, claw and articulated spindles, supporting of spindles, etc.

Gearboxes can be produced with the following modules and maximum output twisting moments Mk_{max} :

- Spur gearboxes – module 1–50 mm, Mk_{max} 560 kNm
- Bevel gearboxes – module 2–18.5 mm, Mk_{max} 70 kNm
- Worm gear units – module 2–20 mm, Mk_{max} 100 kNm

Inspection and Straightening Lines for Hot Bar Finishing

Inspection and straightening line for bar finishing enables to increase the added value of the rolled bar material. It enables to increase material quality parameters, such as straightness, achievement of precise dimension within the tolerance from IT9 to IT11, surface quality, absence of inherent and surface defects, quality of material and last but not least the length-dimensions in the required tolerances.

Technological arrangement and layout of the straightening and inspection line enables to charge and receive bundles of bars from the input store and to unscramble them, to descale the bars by the grit blast machine and to do the technological chamfering. After this phase, the bars are straightened by a straightener. Quality of material and surface and inherent defects are evaluated in the non-destructive testing section. Defects of bars are colour-marked. Defective bars are sorted out according to the type of defect and transported to the workplace enabling necessary repairs. Defective spots are ground or cut out of the bars and the repaired bars are returned

Inspection and Straightening Line for OEMK Stary Oskol in Russia

Main Parameters:	
Ø of bars	from 20 to 83 mm
Length of bars	from 5.5 to 12 m
Weight of packets	10 tons
Input curvature	5 mm/m
Ultimate strength	1,500 MPa
Yield point	1,300 MPa
Yearly capacity	120 thousand tons

back to the line. Furthermore, bars can be divided into commercial lengths, chamfered and marked in the line. Bars are bundled, weighed, bound and prepared for dispatching in the output section of the inspection line.

Lines for glazing material treatment are completed by a peeling machine, smoothing straightening machine, preservation and packing into foils. Exceptional technical solution of the line enables high yearly capacity, achieving high parameters of quality. Advantages of the line involve high flexibility enabling the output of bars in several points of the line and re-integration of bars into the line.

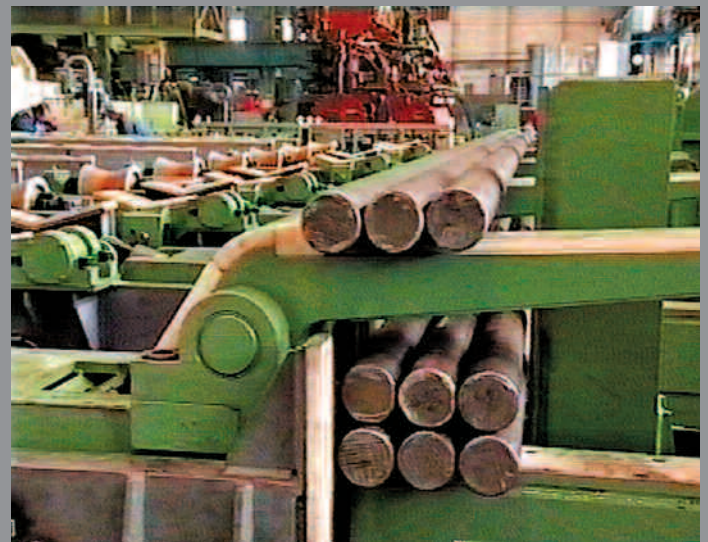

Separating of round iron in the line supplied to Sandvik, Sweden

General view into the hall with inspection and straightening line at OEMK Stary Oskol, Russia



ŽDAS Straighteners Have Good Reputation in the World



In connection with the development of Chinese metallurgical industry, ŽDAS became one of leading suppliers of straighteners and straightening lines for this huge industry. Six lines with straighteners of various sizes, with two or nine straightening rolls were delivered to Chinese companies. The biggest of them, the XRK 2-220, is an oblique two-roll straightener processing

bars up to 220 mm in diameter. The XRK 10-150 ten-roll straightener is a designing novelty then. Series of straighteners XRK 3/4-300 for tubes for Arcelor Mittal and XRK 2-300, XRK 9-100 and XRK 9-40 for bars for Trinecké železářny rank among other interesting job orders for the straightening lines. The XRK 2-80 polishing machine for FERROMORAVIA Staré Město represents the field of special straighteners.

Interesting equipment are the straighteners built as parts of inspection straightening lines for OEMK in Stary Oskol in Russia. With respect to wide range of bars straightened, being 20 to 83 mm in diameter, having high strength of material straightened, the straighteners would have to be doubled. This would bring high demands on transfer mechanization and complications in solving the supply of energies and exhaustion of scale. By installing the atypical XRK 15-100 straightener with fifteen straightening rolls, the line got simplified and, after having been tuned up, it works with high reliability.

Main parameters:

Number of straightening rolls	2 - 16
Bars to be straightened	Ø 5 - 350 mm
Tubes to be straightened	Ø 6 - 400 mm
Length of material to be straightened	3 - 15 m
Output attained	as per customer's specification
Special requirements	independent machine, inclusion in the line, standard straightening, polishing etc.



View of the XRK 15-100 straightener

XRK 2-220 straightener

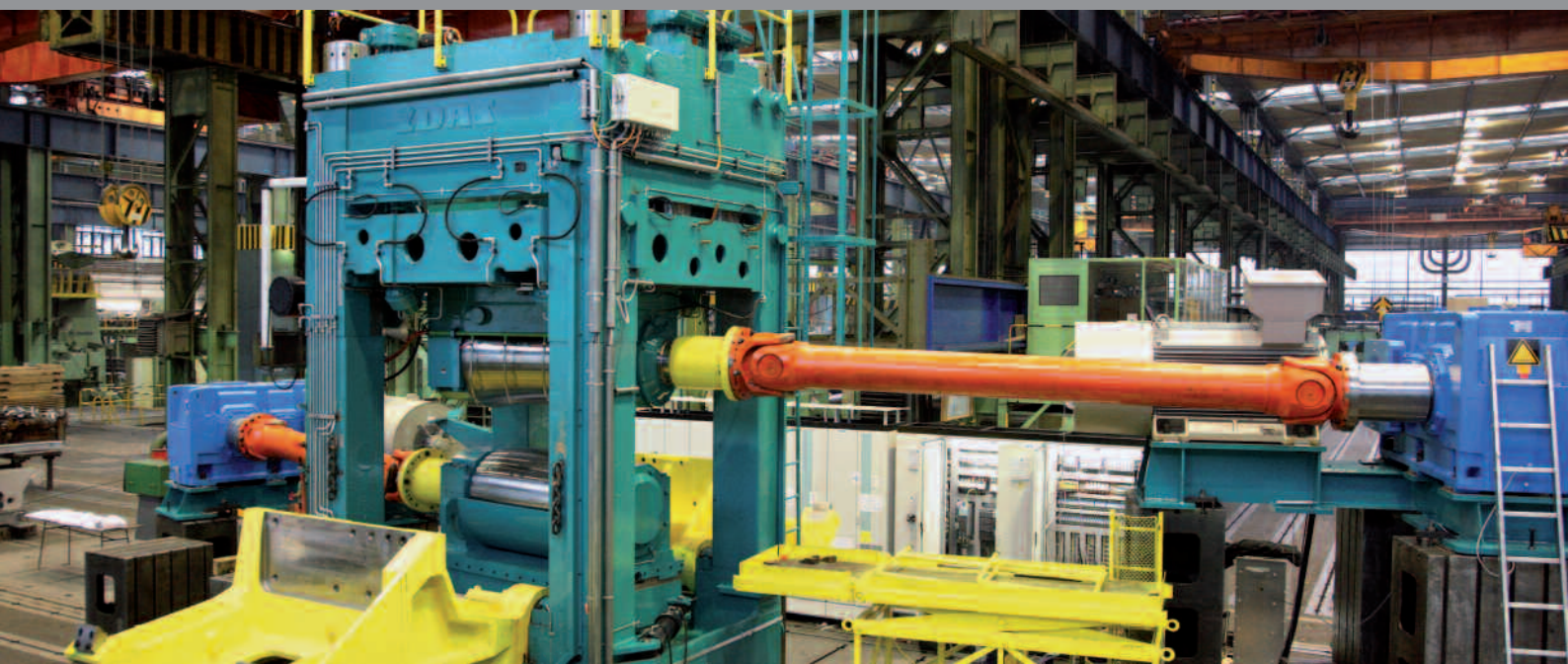



Selected References of Rolled Product Processing Equipment after the Year 2000

- Inspection line d=75-360 mm, l=3-13 m (Sweden - SANDVIK)
- Inspection line d=75-500 mm, l=3-13 m (Sweden - SANDVIK)
- Straightening and inspection line (Russia - OEMK Stary Oskol)
- Straightening, peeling, polishing and inspection line (Russia - OEMK Stary Oskol)
- Slitting line 1.8 - 8 x 1550 (Slovak Republic - U.S. Steel Košice)
- Slitting line 0.25 - 2 x 1500 (Slovak Republic - U.S. Steel Košice)
- Compact straightening and shearing machine 0.5 - 2 x 1500 with an uncoiler and a piler (Czech Republic - ROSSO Steel Mirošov)
- Rail straightening machine - horizontal (Spain - SMS)
- Rail straightening machine - horizontal (China - SMS)
- Straightening machine of heavy plates RS 4-6 x 1750 (Austria - Voest Alpine)
- Straightening machine of heavy plates RS 6 - 12 x 1750 (Austria - Voest Alpine)
- Straightening machine of heavy plates RS 0.5 - 3 x 1750 (Czech Republic - ROSSO Steel Mirošov)
- Oblique straightening machine XRK 2 - 150 (China - Jiangyin Xing Cheng Steel Works)
- Oblique straightening machine XRK 9 - 100 - 6 (China - Bao Steel Group - Shanghai No. 5 Steel Co.)
- Oblique straightening machine XRK 9 - 100 (Czech Republic - Třinecké železárny)
- Oblique straightening machine XRK 9 - 40 (Czech Republic - Třinecké železárny)
- Oblique straightening machine XRK 15 - 100 (Russia - OEMK Stary Oskol)
- Uncoiler - diameter 300 - 200 (Belgium - M.A.M. Belgiim)
- Pendular shears for billets of Ø 100 - 110 (Czech Republic - TŽ Třinec)
- Drum shears 0.14 - 0.5 x 1030 (Czech Republic - DEL / US Steel Serbia)
- Drum shears 0.14 - 0.5 x 1030 (Slovak Republic - U.S. Steel Košice)
- Drum shears 0.14 - 0.5 x 1030 (U.S.A. - LITTLE USA)
- Pickling line (U.S.A. - SMS - DEMAG)
- Tube preservation line (Slovak Republic - Železiarne Podbrezova)
- Straightening and cooling line for rail axles (Russia - Uralvagonzavod Nižnij Tagil)
- Oblique straightener XRK2-90 (China, Jiangyin Dongchen)
- Oblique straightener XRK2-70 (China, Jiangyin Xing Cheng Steel Works)
- Complete overhauls and reconstructions:
- Cut-to-length line 0.8 - 3.0 x 1600 (Czech Republic - OUTOKUMPU Chynov)
 - Cut-to-length line 0.5 - 3.0 x 1650 (Czech Republic - ROSSO Steel Mirošov)
 - Reconstruction of the right half of the cooler KJT (Czech Republic - Třinecké železárny)
 - Reconstruction of the small-section mill train ŽDB (Czech Republic - Vitkovice Ostrava)
 - Reconstruction of the recoiler of the rolling train KVARTO 1400 (Czech Republic - ALINVEST Břidlična)



Metallurgy

Steel Production

Annual capacity of the Steel Plant is 60 thousand tons of steel. The steel made is either poured into ingot moulds (ingots) or into moulds (castings). A wide range of steels is produced, from structural, low- and medium-alloy steels including tool steels, to high-alloy (Cr, Ni, Mn), austenitic and special steels intended for aerospace and power engineering.

Manufacturing facilities

Steel making takes place in three electric arc furnaces (EAF), one ladle furnace (LF) and a deep-deoxidation & vacuum degassing facility also offering the possibility of vacuum decarburization of high-alloy chrome liquid alloys (VD/VOD).

Capacity of production units

No. 2 EAF	16 to 22 tons	LF 14 to 22 tons
No. 3 EAF	4 to 8 tons	VD 14 to 22 tons
No. 4 EAF	12 to 19 tons	VOD 14 to 19 tons

Materials produced

Carbon steels
Low-alloy and medium-alloy steels
High-alloy steels
Nodular cast iron

According to the customer's requirement, if the condition of molten metal (heat) accumulation is satisfied.

Production of high-grade steels processed using vacuum ladle refining technology (VD/VOD/VIC). More than 2,000 grades of steels can be selected.

VD – vacuum degassing

VOD – vacuum oxygen decarburization

VIC – vacuum ingot casting

Production Method

The EAF, LF & VD/VOD integrated workstation offers high variability of the molten-metal-making process, molten metal processing and pouring.

Manufacturing process is chosen according to customer requirements, mainly with regard to the range of chemical composition, ultrasonic testing, micro- and macro-cleanliness, gas content etc., comprises both primary and secondary metallurgy steps and enables to achieve, on a standard basis, high qualitative parameters, flexibility and respond to customer wish within a reasonable time.

Guaranteed are

Gas content (H₂, N₂, O₂), micro-cleanliness to DIN 50602
Ultrasonic testing to SEP 1921
Austenitic grain size

Production of Castings

The manufacturing program is currently aimed at MAGMA aided castings (program support of hardening simulation and cooling) being demanding for their shapes and materials; weight of these castings is ranging from 200 kg to 40,000 kg of rough casting weight, the maximum dimensions being 8,500 x 4,800 x 3,000 mm.

Sand mixtures used:

Standard self-hardening moulding mixtures

Heat treatment

is carried out in modernized natural-gas-fired furnaces with automatic temperature control, temperature difference throughout the furnace space does not exceed ± 5 °C. The castings can be delivered in normalized condition, water, oil, air quenched and tempered.

Fettling and surface finish,

being included in the manufacturing process, is performed through ordinary cleaning operations, steel shot blasting (Velebrator), compressed-air grit blasting. Rough grinding is carried out at the robotized workstation ANDROMAT and using portable grinding machines.

Delivery condition of castings:

- fettled castings
- machine-fettled castings
- rough machined castings having machining allowance of agreed size
- complete machined parts

Production of Ingots

Manufacturing program:

The range of ingots produced in the Ingot Shop comprises about 40 types of ingots with weight ranging from 500 kg to 12 tons. The ingots are intended for open die forging (octagonal polygonal ingots of 8K series) and rolling (pentadecagonal polygonal, round and slab-type ingots). Production of new types of ingots can also be agreed according to customer's requirement.

Manufacturing process:

Ingots are bottom poured into ingot moulds on plate lined with high-clayey refractory casting material. When pouring ingots, the steel surface is protected with casting powder. Ingot top is treated using isolating or exothermic mixtures/powders. During steel casting, argon protection of the flowing metal is used. Based on customer requirement/our recommendation, ingots can be delivered as annealed (soft annealed, stress relief annealed).

Delivery condition:

- non-split ingots with their tops
- ingots split to required parts
- certificate of chemical composition
- absence of radioactivity certificate
- annealing certificate - on request
- also ingots in hot condition can be delivered to customers

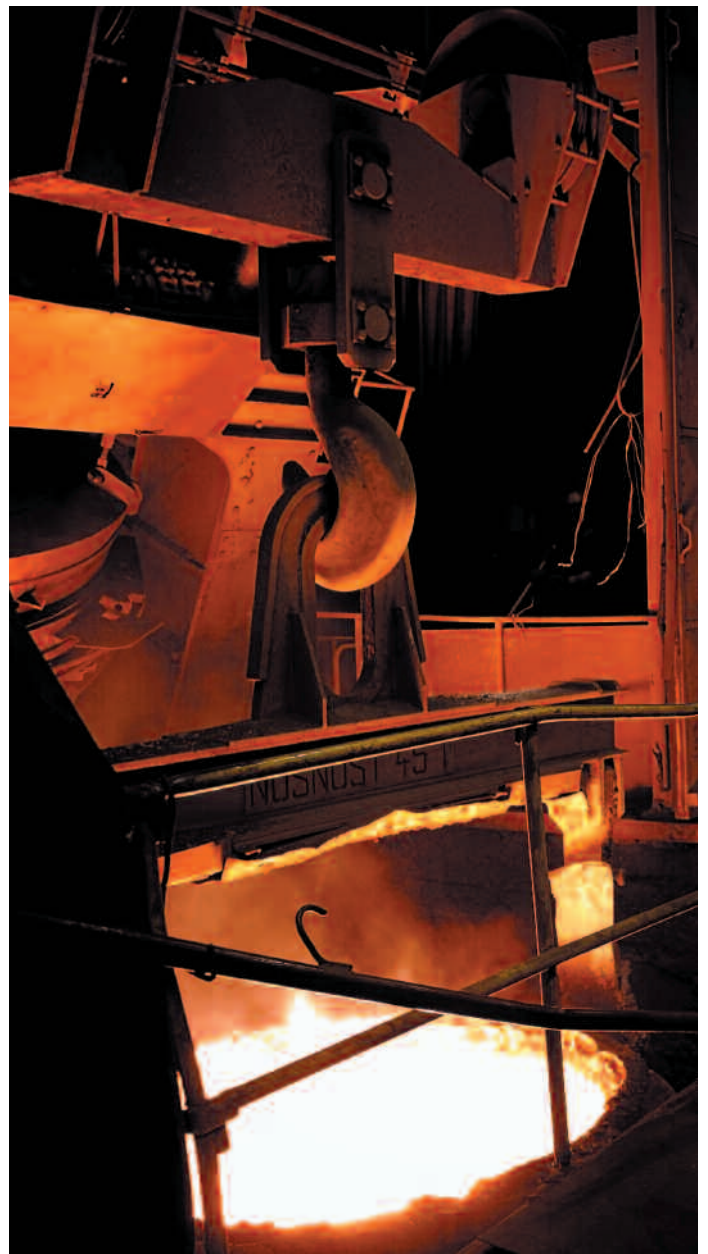



Metallurgy

Open Die Forgings

The Forge Shop has been manufacturing open die forgings since 1966 in a comprehensive range of shapes, with weights ranging from 20 kg to 9,000 kg.

Steel used, made solely at ŽDAS Steel Plant:

Structural standard-grade steels intended for various application
Structural carbon steels for quenching and tempering, case-hardening etc.

Structural alloy-steels of various types – Mn, Si, Cr, Ni, Mo, V, Al, W Alloy, high Cr, Ni, Mn content steels

Tool carbon and alloy steels for forming tools

Steels for special application

Manufacturing facilities:

Integrated forging units with three open die forging presses of in-house design, CKV 630, CKV 1250 /1600 and CKV 2250, with rail-bound manipulators

Heating furnaces (car-hearth + chamber type)

Heat treatment furnaces (car-hearth + soaking type)

Quenching tanks (water + oil)

Material-dividing saws – up to a diameter of 1,000 mm

Sampling saws

Delivery condition, according to customer's requirement:

Forged and heat treated

Rough machined

Finish machined

Quality and Certification

The Metallurgy Plant has ultrasonic, magnetic and liquid-penetrant testing facilities according to ČSN, DIN, EN and ASTM standards available.

Testing personnel is qualified in accordance with EN 473 and SNT-TC-1A standards.

Final inspection documentation and certificate of conformity are issued in accordance with EN 10 204 and customer's technical requirements.

The lab is incorporated in a system being accredited to ISO 9001:2000 and they, on a regular basis, take part in inter-laboratory tests in order to provide high quality of results.

Patterns

The Pattern Shop produces pattern equipment both for hand and machine moulding, piece and series production as well. Workmanship classes depend on customer's requirement, the material being polystyrene, wood, plastics, metal and combinations of the named materials.

Complete technological equipment is available, providing high quality of all the manufacturing operations, from material preparation including its drying through finishing of the pattern equipment by painting. Available is a well-equipped workstation intended for receipt of production documentation and 3D patterns in majority of engineering standards, e.g. Iges, VDA, STAP, ProE, Autocad, CATIA and CAD /CAM system workstation intended for documentation processing and CNC-machine cutting.

Maximum size of non-split pattern equipment is 10,000 x 5,000 x 4,000 mm. Rotary patterns up to a diameter of 5,250 mm, milled patterns up to a radius of 15,500 mm and 40 deg., working on CNC machine having the work-table size 6,000 x 2,000 mm.





Metallurgical Processes

Electric arc furnaces

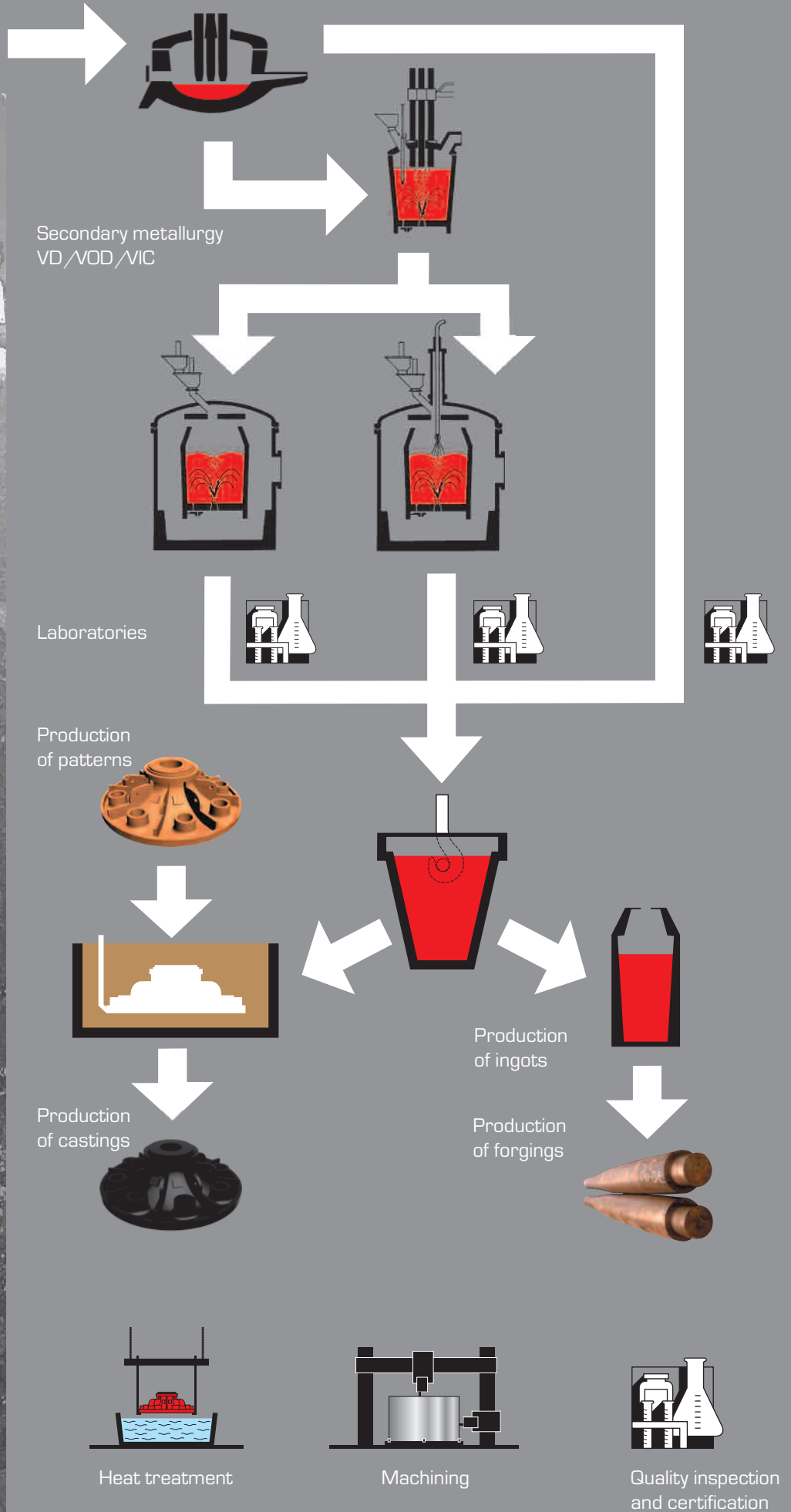

New Technologies in the Metallurgy Plant

New technologies have been implemented in production of castings, such as production of castings from high-alloy fire-resistant materials for power industry, which is closely associated with the development of the power and chemical engineering. Requirements for qualities of fire-resistant steels are determined mostly by working conditions (temperature, pressure, environment) and economic life of the equipment. Modified ferritic steels on the basis of 9–12 % Cr conform to these requirements. They can also successfully replace the expensive austenitic steels by their enhanced fire-resistance. In terms of consolidation of the company's position in the market of castings for power equipment, production of technologically demanding heavier castings for the customer ŠKODA POWER Plzeň has been initiated. Within the scope of new technologies, production of high-alloyed material castings for water turbines has been commenced and production of castings intended for high negative temperatures continued. Castings from special high-alloyed cast iron suitable for turbine clothing and equipment operating e.g. with seawater have been produced in the frame of the grant project TANDEM. The ŽDAS Casting Plant is the only one within the Czech Republic, prepared to produce larger castings from this material at present. The forging section was engaged in research and development of modern tool steel intended for forming tooling. The project is targeted to the development

of the production technology of tool steel for hot operation with forging dies instead of standard steels, thus extending the operating life from 30 to 100 %. The benefit of this project consists mostly in managing of a completely new technology with the advantage of production of a product in better quality, higher utility value and lower manufacturing costs. The project ENSTEEL dealt with a problem aimed at finding the procedure of efficient micro-alloying of steels, development and proofing of the technology of forming and heat treatment of dimensional forgings in the relationship with products of various nominal dimensions (tubes, sheets and strips) from new steels with extraordinary parameters of mechanical properties.

Furthermore, new forgings production technology (so called cross-forging) was proofed, using the maximum force of the 2,250-ton press. The forging is aimed at smith's welding of internal porosity of ingots. Heat treatment of couplings forgings for oil industry from the material 4130 was proofed. Mounted bushings with a blind hole upset in jigs as well as large-dimensional rings were forged.

Heating furnace torch system was reconstructed in the forging plant, new type of ingot 8K 11.5 was introduced into the current production of forgings and circulating pump was installed into the hardening tank, enabling reduction of water consumption by products hardening.





Reference Examples of Castings

Castings for extractive industry



Castings for power engineering

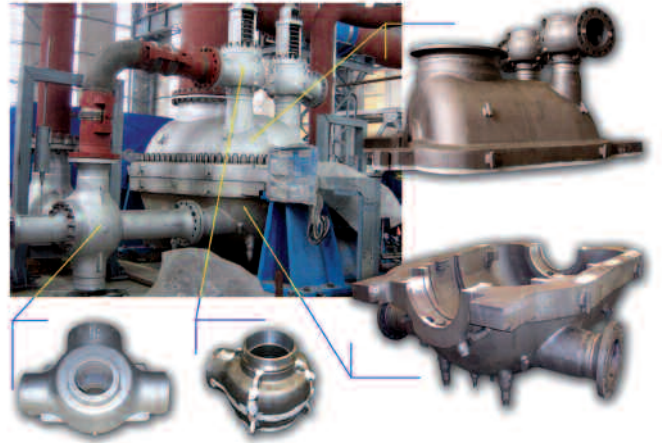

Castings for Francis turbine



Castings for steam turbines

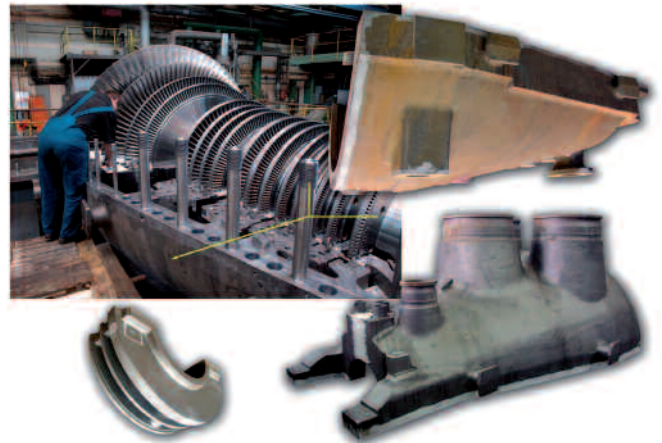

Castings for Kaplan turbine



Castings for power engineering





Reference Examples of Forgings

Forgings for wind-power plants



Forgings for ship engines

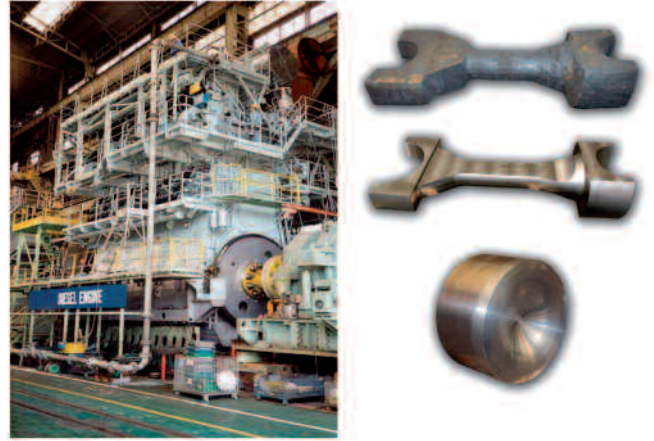

Forgings for nuclear research

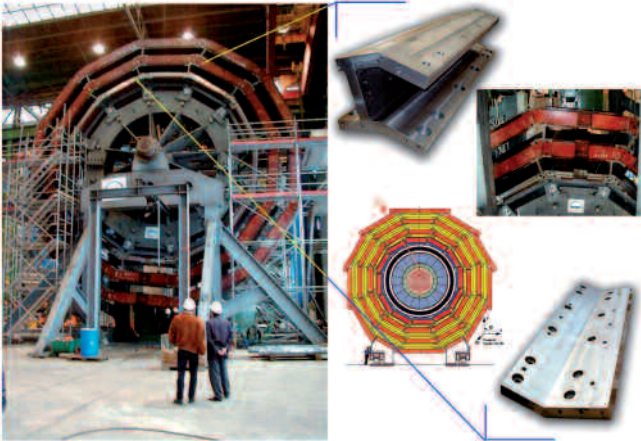

Forgings for aircraft industry



Forgings for shipbuilding industry



Forgings for power engineering





Manufacture According to Customer-Provided Documentation

Thanks to modern production base and continual investments in processing machines and equipment, a part of capacities can be applied to manufacture of equipment according to customer-provided documentation. In addition to utilisation of machine stock, this also results in development of co-operation with the customer who has a clear conception of products being further used for assembling the own-supplied equipment.

In this field, export orders unambiguously prevail in the joint stock company ŽĎAS. They are mostly focused in engineering branches, eventually paper or plastic foils processing. The production is then intended for customers in Britain, Holland, Austria and other E.U. countries.

High inter-yearly sales accrual in this field proves the fact that ŽĎAS, a.s. comes to be a distinguished manufacturing partner of the world leading suppliers of engineering technologies.

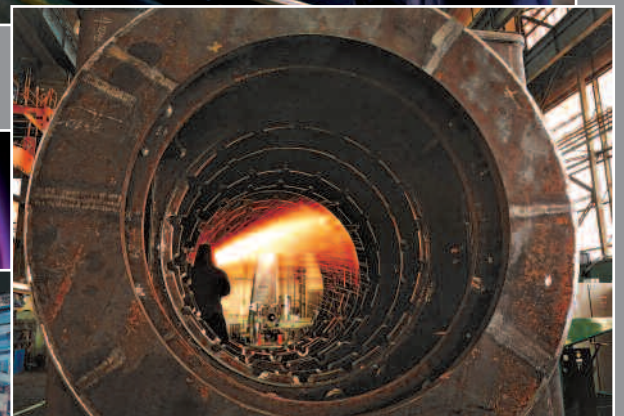

Tooling Production



We offer to our partners development of forming technologies and press tools, tool designing and production according to our own as well as the customer-provided documentation, to the tools testing and proofing by incorporating and commissioning at the customer. We are aimed at production of large press tools for structural parts. You can meet our products at many inland and foreign customers, especially in the field of the automotive industry. We offer optimal technical solutions, within the required delivery terms and for affordable prices, and within the Integrated Management System according to EN ISO 9001:2008.



Product offer

- individual press tools
- progressive press tools
- transfer press tools
- tools for pressing lines
- notching press tools
- special tools and jigs
- special gauges and measuring jigs
- die holders, dies
- production of parts for precision engineering
- production of parts for power engineering



Press tools design department is engaged in designing a wide broad-spectrum of press tools aimed at the automotive industry.



We elaborate:

Projects of pressing

Simulation of drawing – externally

3D designing – CATIA V5

Detail layout of assembly drawings

Creation of 3D models of parts – CATIA V5, Unigraphics NX

2D design – AutoCAD

Data format:

Catia, Unigraphics, Autocad, Iges, Step

CAM Software:

Work NC, Unigraphics NX

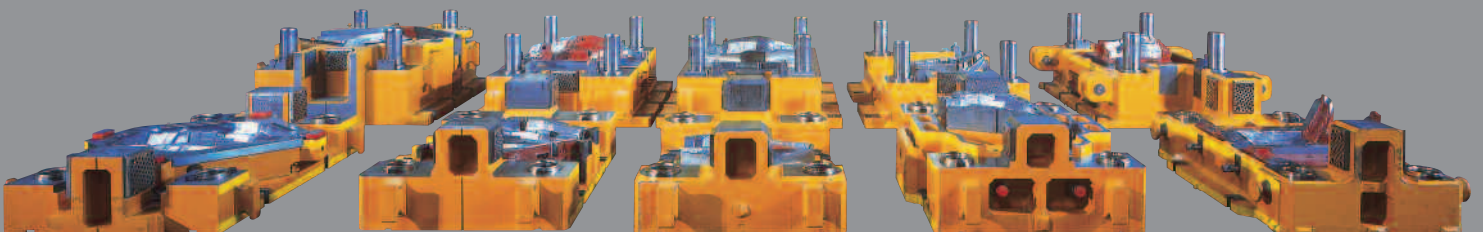

References

Tooling for automotive industry

ŠKODA Auto, a.s., Mlada Boleslav
Muller Weingarten Werkzeuge GmbH, Germany
Schuller Cartec GmbH, Germany
Voestalpine Polynorm Grau GmbH, Germany
ThyssenKrupp Drauz Nothelfer GmbH, Germany
GEDIA Gebruder Dingerkus GmbH, Germany

Tooling for consumer industry

KARSIT s.r.o. Prague, Czech Republic
MEVA a.s. Roudnice nad Labem, Czech Republic

Tooling and parts for power engineering

Siemens Electric Machines s.r.o., Czech Republic
ČKD Blansko Engineering, a.s., Czech Republic
Krušnohorské strojirny Komořany a.s.,
Czech Republic
Brush SEM s.r.o., Czech Republic

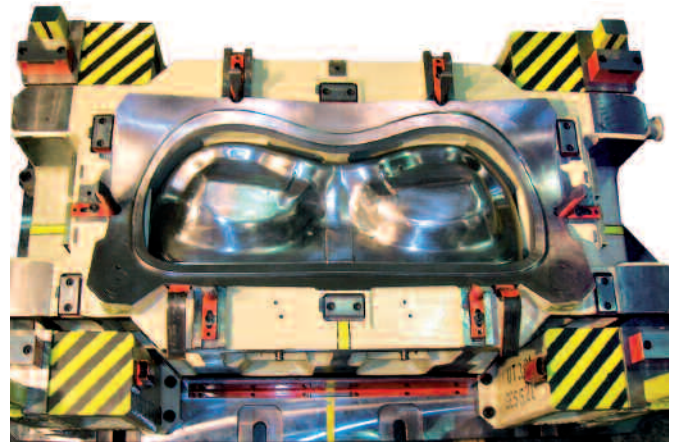

Production Facilities

Free-surface machining equipment

Machining centres (4 centres)
Measuring centre (1 centre)
Electrical erosion machine (altogether 2 machines)
Dredge (1 machine)

Surfacing equipment

Horizontal boring and milling machine (altogether 10 machines,
5 of them CNC system MEFI)
Boring machine (2 machines – Heidenhein system)
Milling machine (4 machines)
Surface grinding machine (5 machines)

Rotary machining equipment

Plain grinding machine (altogether 2 machines)
Lathe (5 machines)

Tool testing equipment – presses

Mechanical presses (altogether 3 presses)
Hydraulic presses (altogether 5 presses)

ZDAS

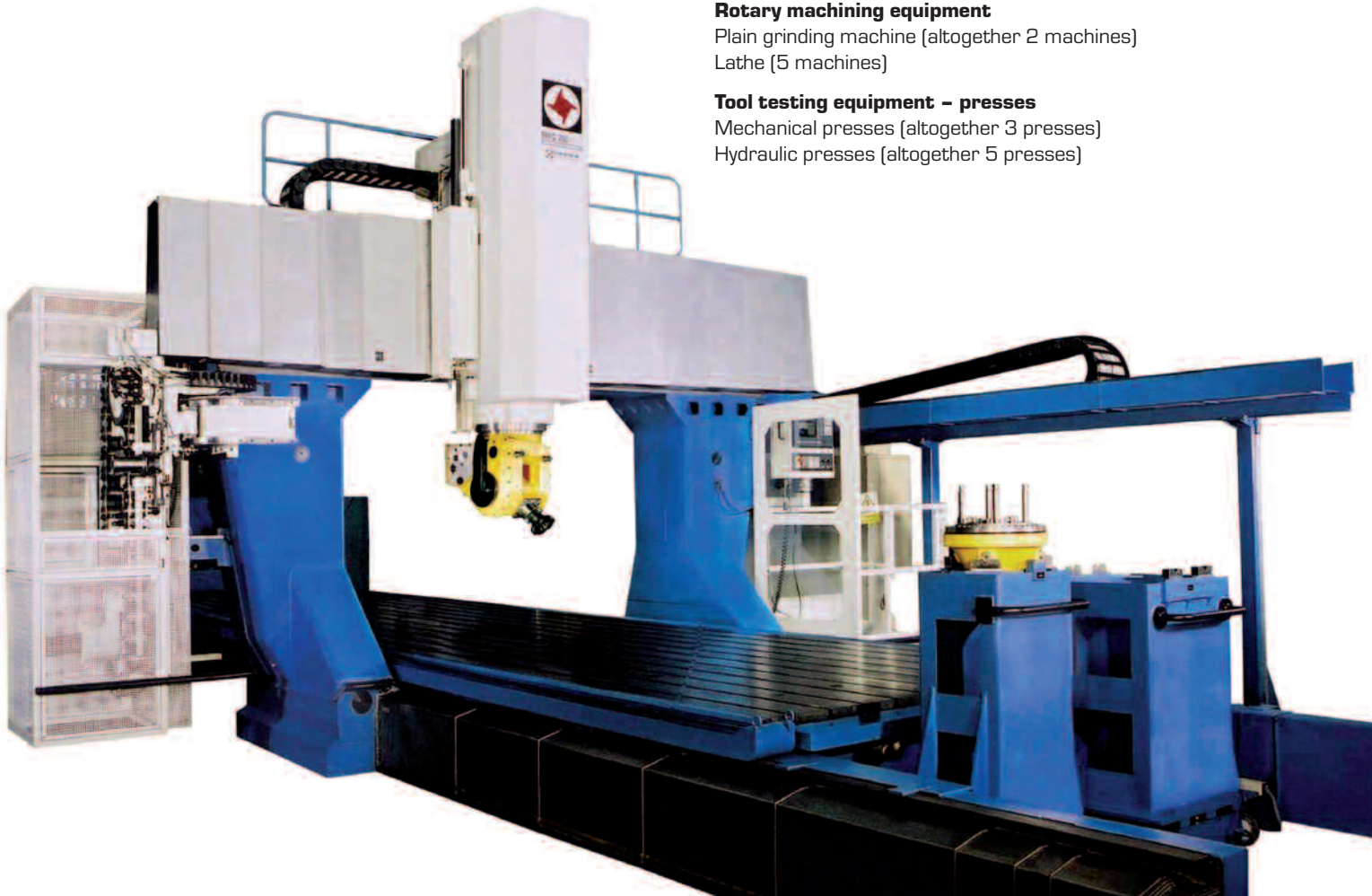



Engineering Production

The Engineering Production department ensures production and assembly of machines and equipment according to own manufacturing documentation worked out in the company. Engineering Production also offers manufacture of equipment according to customer-provided documentation.

Machining centre (1 machine)

Machining of pieces with dimensions (width x height x depth) of 5,500 mm x 4,000 mm x 14,000 mm

Lathes (altogether 44 machines)

Machining of pieces of diameter up to 2,100 mm, length up to 10,000 mm

Vertical boring and turning machines (altogether 11 machines)

Pieces of diameter from 200 mm up to 4,700 mm, height up to 2,500 mm

Honing machine (altogether 3 machines)

Pieces of diameter from 20 mm up to 1,000 mm, length up to 6,000 mm

Plain grinding machines (altogether 6 machines)

Pieces of diameter from 5 mm up to 1,000 mm, length up to 10,000 mm

Vertical grinding machine (1 machine)

Pieces of diameter up to 2,600 mm, maximum ground diameter 2,500 mm, maximum workpiece height 1,700 mm, maximum ground height 1,400 mm, minimum ground hole diameter 200 mm, maximum ground hole length 800 mm

Surface grinding machines (altogether 5 machines)

Surface 2,000 mm x 8,000 mm, height 2,250 mm

Gun-boring machines (altogether 2 machines)

Pieces of diameter from 31 mm up to 1,000 mm, length up to 13,000 mm

Horizontal boring and milling machines (altogether 56 machines)

Machining of pieces of height up to 5,000 mm and length up to 16,000 mm on clamp plates, up to 4,000 mm x 4,000 mm on turntables

Knee-type milling machines (altogether 12 machines)

Machining of pieces of dimensions up to 300 mm x 1,400 mm, height of 300 mm

Planer type milling machines (altogether 10 machines)

Machining of pieces of dimensions up to 2,000 mm x 8,000 mm, height of 1,500 mm

Planers (altogether 2 pieces)

Machining of pieces of dimensions up to 2,000 mm x 8,000 mm x 1,000 mm

Shaping machines (altogether 3 machines)

Allow the machining along circumference up to the height of 1,600 mm and in the hole up to 750 mm, maximum diameter of clamping table is 1,400 mm

Drilling machines (altogether 10 machines) – diameter of drilling up to 100 mm, maximum height of piece – 1,600 mm

Gearing (altogether 24 machines)

Spur gearing m 0.6-30, wheel diameter 10 mm – 4,000 mm, width 1 mm – 600 mm

Bevel cyclopalloid gearing m 7-20, diameter 100 mm – 850 mm

Bevel straight, helical gearing m 2-14, diameter 40 mm – 800 mm

Worm wheels m 1.5-20, diameter 40 mm – 1,500 mm

Coupling hub (barrel-shaped gearing) m 1.5-20, diameter 40 mm – 1,200 mm

Rack m 1-12, by milling m 12-45, length 20 mm – 4,000 mm, width 1 mm – 400 mm

Grinding of spur gear m 2-30, diameter 40 mm – 2,000 mm, width 1 mm – 650 mm

Gear shafts m 1.5-25, length of piece 200 mm – 7,500 mm, diameter of gearing 50 mm – 800 mm, length of gearing 1 mm – 4,000 mm

Endless screws m 1.5-20, diameter 20 mm – 300 mm

Internal gearing – straight m 1-12, diameter 30 mm – 1,500 mm, width 1 mm – 400 mm



Machining centre FRUG 450



Fixed-bed milling machine with sliding portal FRF 300-V/A6





Inspection

Gearing accuracy check on the HOEFLER measuring equipment, of the wheel diameter up to 2,600 mm, including the print out of results report.

Welding

Welding workplace equipped with CLOSS robots and positioning device for pieces up to 3,700 mm x 7,000 mm, height 3,000 mm.

MMA, MIG, MAG, TIG welding machines for pieces up to 4,000 x 3,500 x 14,000 mm and weight to 80 tons.

Stainless steel weld deposition workplace (MIG, MAG, FCAW, SAW welding methods)

Al and Cu alloy weld deposition (TIG, MAG welding methods)

Welding of gears with diameter up to 2,000 mm when preheated in the rotary-hearth furnace

Stress relieving by annealing or special vibrating technology (providing documentary evidence of parameters)



Pickling

Pickling in Ferropur (NaH + NaOH), plates from width of 5 mm, tubes from Js 25, maximum length 6,000 mm

Pickling in HCl, sheets up to width of 5 mm, tubes up to DN 25, maximum length 6,000 mm

Stainless steel dip pickling

Stainless steel spray pickling

Dimensions of tanks 1,000 x 2,200 x 6,000 mm, maximum weight of batch 4,000 kg

Ionic Nitriding

Vessel	piece diameter	650 mm
--------	----------------	--------

	piece length	7,400 mm
--	--------------	----------

	batch weight	8,000 kg
--	--------------	----------

Vessel	piece diameter	1,100 mm
--------	----------------	----------

	piece length	
--	--------------	--

- hung-up	4,600 mm
-----------	----------

- standing	5,000 mm
------------	----------

batch weight	12,000 kg
--------------	-----------

Vessel	piece diameter	1,100 mm
--------	----------------	----------

	piece length	2,000 mm
--	--------------	----------

batch weight	5,000 kg
--------------	----------

Annealing

Annealing chambers with dimensions:

4,080 mm x 3,000 mm x 9,400 mm

4,200 mm x 2,500 mm x 9,400 mm

5,100 mm x 2,500 mm x 8,800 mm

weight 32,000 kg

Hardening, Quenching and Tempering, Chemical/Heat Treatment

Pieces with diameter up to 750 mm, length 1,800 mm, weight 2,500 kg

Electric car-type furnaces – maximum dimensions 1,000 x 1,000 x 2,400 mm, batch weight 3,000 kg

Heat Treatment of Slender Pieces

Pit furnace, oil, water: For pieces of maximum diameter up to 800 mm, length 6,800 mm, weight 10,000 kg

Material Cutting

Water beam cutting up to width of 50 mm

Flame cutting up to width of 220 mm

Cutting

Compressed Air Blasting

Compressed air grit blasting for pieces of maximum dimensions 8,000 mm x 4,500 mm x 3,500 mm, weight up to 32,000 kg



HYDRAulic Test Lab

The core branches of production program of ŽĎAS, a.s. include development and manufacture of hydraulic systems. These are represented e.g. with manifolds fitted with hydraulic elements, hydraulic cylinders, valves etc. During manufacture and before equipment assembly, it is always necessary to properly test the hydraulic units at certified test stations. This is the only way to eliminate any manufacturing defects, faults in the product design or incorrect settings of basic parameters. Finally, such a procedure saves time and, primarily, it avoids loss in production plants.

Being aware of this fact, ŽĎAS, a.s. offers a well-equipped hydraulic test room to its partners and customers to push forward the possibilities of testing the hydraulic elements.



Services

External Assembly

External Assembly Plant is a separate branch of ŽĎAS, a.s. performing and providing disassembly, repair, erection, adjustment and commissioning of the equipment. Our staff is provided with up-to-date erection tools and instruments. The division guarantees high productivity and quality of erection work, short erection times and a low price. The professional and language skills of our personnel guarantee good results abroad. Heavy machinery can be disassembled and displaced even in straitened circumstances. Personnel of the External Assembly has successfully carried out erections of large investment units such as the medium and light rolling mill at Poldi Kladno, medium section rolling mill at NH Ostrava Kunčice as well as supervisions of erections of the medium section mills in Iran, Turkey, Romania and the billet mills in Pakistan and former Yugoslavia. For foreign customers, we have carried out erections or supervisions of erections of machines and equipment.

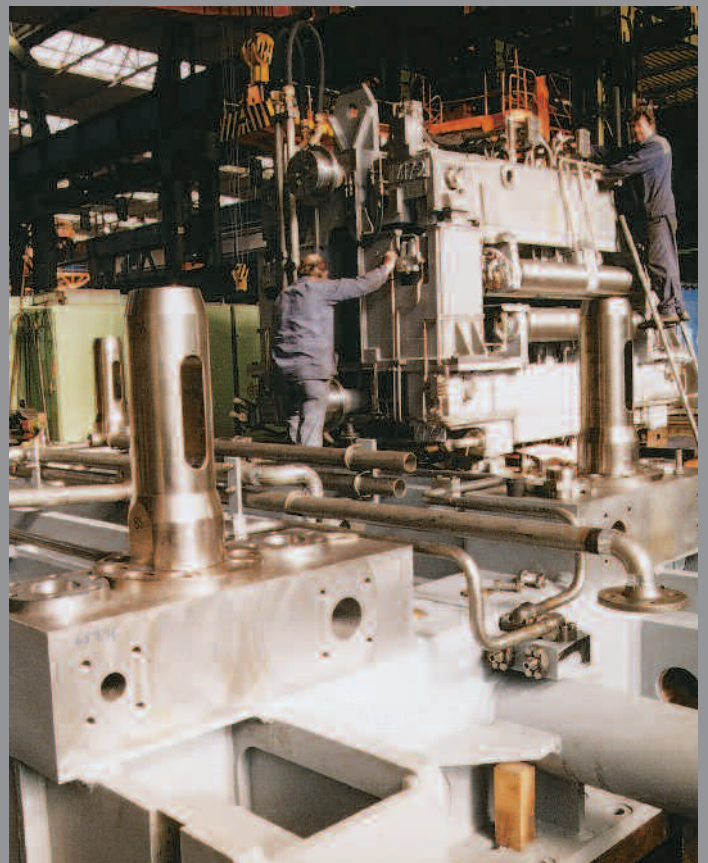

Reconstruction and Modernisation

Part repairs and overhauls of unit equipment and production lines usually result from costly maintenance of the existing equipment, its low output and demanding requirements for ecology of operation. Based on these facts, most of repairs are focused in the following fields:

- design and process layout of the required parameters
- repair and exchange of active mechanical parts
- exchange of sealing material
- reconstruction and modernisation of drive units
- installation of control and automation elements

The market development tends to increasing quality of product, narrowing down the manufacturing tolerances and introducing new types. At the same time, there is a constant stress on reduction of price. To satisfy these requirements, new products are introduced or the existing one are reconstructed and modernised. For both solutions, ŽDAS disposes of teams of specialists ready to meet the necessary requirements.

Complete Equipment Deliveries

Fully completed deliveries of equipment have been an established practice in ŽDAS Company for a long time. It means that in addition to design, engineering, production and assembly, ŽDAS Company ensures also the individual part components such as for example hydraulic cylinders, aggregates or control units. It concerns the own design and production at ŽDAS, engineering workplaces as well as modern production plants equipped with machine tools and technological workplaces for surface treatment are available. Besides hydraulic cylinders, hydraulic aggregates and control units are produced.

Service

In the world of advanced industry, relationship between the supplier and the customer involves also service and maintenance of the supplied equipment after delivery. Therefore, the ŽDAS Service department is available 24 hours a day and the experienced service staff are able to deal with any problem and ensure trouble-free operation of the supplied machinery.

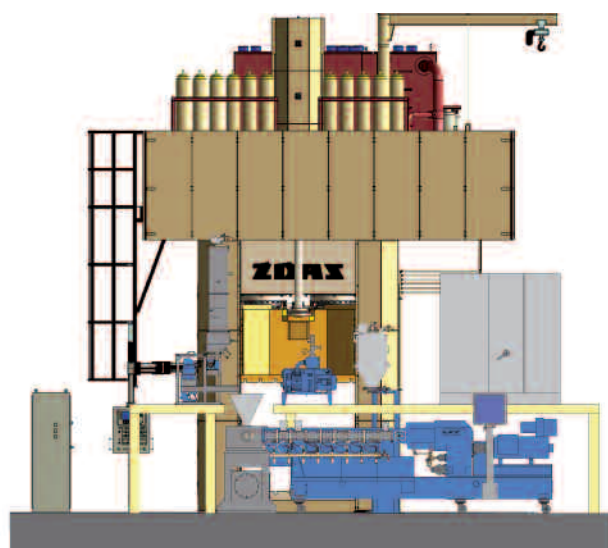
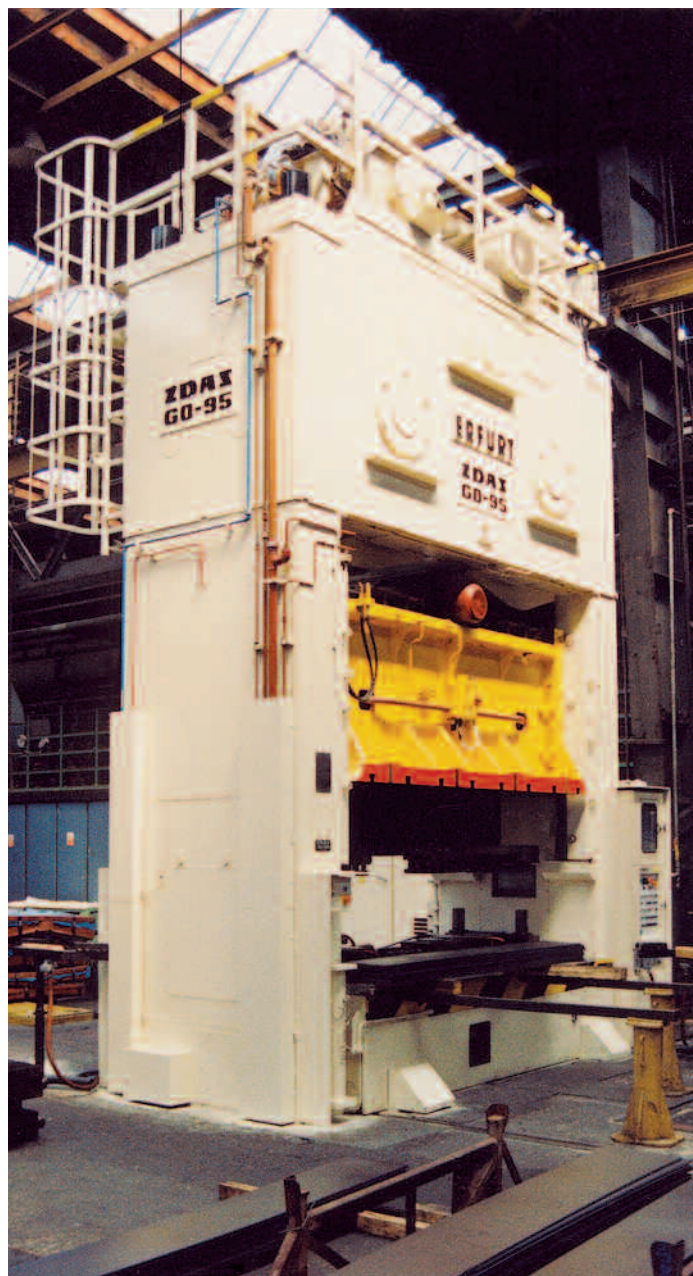

Line with CYAA hydraulic press for production of car fillings

ZDAS

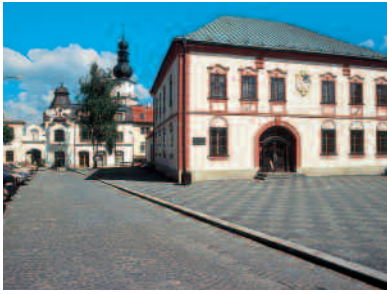

www.zdarns.cz



www.ubytovnazdas.cz



www.hotel-svratka.cz



www.gcsvr1932.cz

ZDAS and the Region

The factory plants and chimneys of the ŽĎAS Company form a viewpoint of the town Žďar nad Sázavou. On the opposite side, they are counterbalanced by historical premises of the former Cistercian monastery dominated by the Pilgrimage Church of St. John of Nepomuk on Zelena hora hill, built by an outstanding architect Jan Blažej Santini Aichl. This monument was included in the list of the world's cultural heritage UNESCO in 1994.

Besides a number of cultural activities supported by the joint stock company ŽĎAS, there exists also a positive and long-time co-operation with the local government representatives. They fully understand the importance of a company that, with its turnover, is the main contributor to the town budget.

Through the Logistics department, the joint stock company ŽĎAS provides further services. The hotel-quarters ŽĎAS next to the company premises offer inexpensive modern accommodation both for the long-time guests and for the occasional town visitors.

The congress hotel ŽĎAS Svatka in the beautiful nature of the central Bohemian-Moravian Uplands offers congress and family recreation with a high-quality sports and tourist facilities. An attractive nine-hole golf course is available for golf-lovers. In summer, there are many opportunities for hiking and cycling tourism. Downhill skiing course and tens of kilometres of treated cross-country skiing courses next to the main hotel building can be used in winter.

Conference rooms including audio-visual devices are available in the hotel for up to 150 participants, as well as a rehabilitative facility, massages and an indoor swimming pool.

ZDAS



We Think in Larger Correlations

The joint stock company ŽĎAS belongs among the biggest employers of the Žďár nad Sázavou region. That puts great responsibility for constant support of cultural and ecological values on the company. The town as well as the company are situated right in the centre of the protected landscape area Žďárské vrchy. Together, they aim at good quality of life for the inhabitants and visitors.

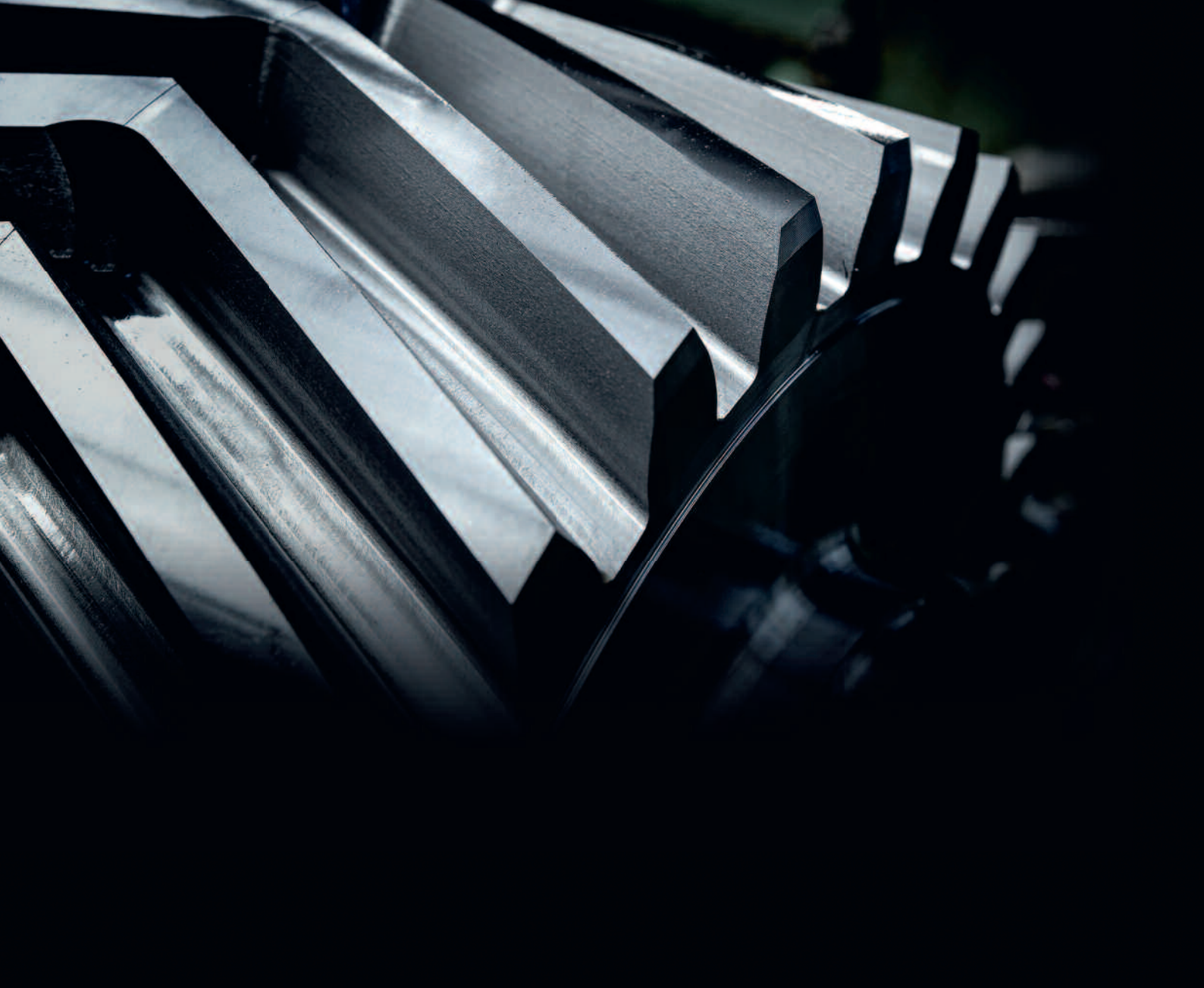

中国华信
CEFC CHINA

CEFC Group (Europe) Company a.s.

Na Příkopě 857/18
110 00 Praha 1
Czech Republic
info@cefceurope.com

www.cefceurope.com

ZDAS

ŽDAS, a.s.

591 01 Žďár nad Sázavou
Czech Republic
Phone: +420 566 64 2124
Fax: +420 566 64 2871
e-mail: zdas@zdas.cz

www.zdas.cz

Commercial Contact

Phone: +420 566 64 2124
Fax: +420 566 64 2871
e-mail: or@zdas.cz

Technical Contact

Phone: +420 566 64 3104
Fax: +420 566 64 2873
e-mail: tr@zdas.cz